

**Textbook**  
**working safely**  
**with the electric**  
**pallet truck and**  
**stacker**



**>NoRisk**



*Textbook working safely with the electric pallet truck and stacker  
NoRisk Veiligheidsopleidingen B.V.*

# Textbook

## working safely with the electric pallet truck and stacker



**QUIZ :** <https://www.noriskveiligheidsopleidingen.nl/quiz/>

# 1. Working Conditions Act

## 1.1 Introduction

All employees are affected by working conditions, regardless of the work they do. Working conditions is an umbrella term for all matters related to health, safety and wellbeing at work. All measures taken to promote safety, health and wellbeing are based first and foremost on the Working Conditions Act.

## 1.2 Structure of Working Conditions legislation

The Working Conditions Act is a framework and does not stipulate any specific rules. Rather, it contains a general description of duties and obligations relating to safety, health and wellbeing at work. The Working Conditions decree sets out the rules about the most common workplace risks in greater detail.

The Working Conditions Regulations contain even more detailed regulations on subjects such as the reporting of accidents, occupational diseases and occupational health and safety services.

*The core principle behind the Working Conditions act is that employees and employers share responsibility for working conditions.*

## 1.3 Occupational health and safety data sheets (AI sheets)

These so-called 'authoritative publications' are intended to flesh out the Act, but they do not belong to the Act proper, unless they are referred to explicitly in the Act.

Examples include:

- AI - 1 Occupational health and safety and absenteeism policy;
- AI - 11 Shielding and protecting machines;
- AI - 14 Business premises - layout, transport and storage;
- AI - 17 Hoisting and lifting equipment and safe hoisting.



## 1.4 Occupational Health and Safety service

Companies are no longer obliged to register with an Occupational Health & Safety (OHS) service, although it is still mandatory to seek expert support and advice, where necessary. This role can be played by an internal or external competent OHS expert. This amendment to the Working Conditions Act is intended to give branches and companies more freedom of choice in the area of working conditions and absenteeism prevention. In order to guarantee the availability of absenteeism

counselling and to give employees the opportunity to visit an OHS consultation hour, suitable arrangements must be made or a contract must be concluded with a registered occupational health physician.

## 1.5 **Netherlands Labour Authority (NLA)**

Netherlands Labour Authority (NLA) falls under the purview of the Minister of Social Affairs and Employment. And it informs, monitors, inspects and, if necessary, obliges employers and employees to improve their arrangements for health and safety. If an employee or employer violates the regulations, the Netherlands Labour Authority is authorised to impose a fine. In addition, the Netherlands Labour Authority stimulates consultation and coordination between employees and employers. The Netherlands Labour Authority investigates the causes of accidents and advises the Minister on additional laws and/or policy regulations.

Netherlands Labour Authority inspectors have the authority to impose an administrative fine if they establish that the Working Conditions Act has been violated. The Ministry of Social Affairs and Employment publishes an annual list of all violations and the associated fines, as part of its immediate-response policy (Dutch: Lik-op-stuk-beleid), which has been in place since 1 November 1999.



## 1.6 **Rights and obligations**

Employers must take measures to optimise their employees' safety, health and wellbeing and align this policy with all other policies in effect within the company.

### 1.6.1 **For employers**

Despite the fact that the Working Conditions Act is a list of general requirements, several clear obligations for employers arise from it:

- Employers must establish good working methods (through work instructions) and provide Personal Protective Equipment (PPE);
- Employers must ensure the workplace features escape routes and first-aid equipment;
- Employers must provide workers with adequate information on and training for the work they have to do;
- Priority must be given to new employees and the employees who are most at risk;
- Employers and employees must have regular meetings;
- Employers must, as far as possible, avoid giving employees monotonous, machine-based work (e.g. assembly line work);
- Employees must give employees the opportunity to maintain or improve their skills.
- Employers must adapt the situation at work (e.g. workplace layout or working methods) to their employees as much as possible;
- Employers must give employees as much freedom as possible in deciding how to do their work;
- Employers must take into account the personal characteristics of employees, such as age, education, experience and their physical and mental condition.  
In short: they have to make sure the right person is in the right position;
- Employers are obliged to describe their OHS policy and all risks present in their company in an RI&E. In addition, employers are obliged to describe all situations that do not meet the requirements set in the Act in an Action Plan;
- Depending on the nature of their company, employers must be assisted by one or more qualified Emergency Response Officers (EROs);
- Employers must implement an absenteeism policy.

### For employees

The Working Conditions Act also imposes various obligations on employees.

Employees also have various general obligations, such as:

- Employees must carry out the work in such a way that they do not endanger themselves or others;
- Employees must be familiar with procedures and instructions and act accordingly;
- Employees must use machines, equipment and the safety devices attached to them correctly;
- Employees are obliged to use personal protective equipment (such as a safety helmet, gloves, shoes and goggles) and to maintain it properly;
- Employees must participate in organised instruction and information sessions provided by the employer;
- Employees must report dangerous situations to the person in charge.

### CE - marking

On 1 July 1995, the European Union introduced a law to ensure that machines can be used safely. This law, the so-called Machinery Directive, lists a range of criteria that new products must meet. If a new product meets the requirements set out in in this Machinery Directive, the manufacturer can affix CE marking to its product and issue a corresponding EC declaration of conformity. CE stands for Conformité Européenne. It is up to manufacturers to establish that the technical solutions they have developed meets the minimum requirements set out in the Machinery Directive. Products that pose serious risks, such as terminal trucks, require an official inspection report issued by an accredited inspection company.



### Risk Inventory & Evaluation ( RI&E )

The rules specified in the Occupational Health & Safety Act are intended to ensure that employees can work safely and healthily in a pleasant atmosphere. All companies must draw up an Occupational Health & Safety (OHS) policy, indicating their arrangements for occupational health and safety and specifying whether they are willing to make funds available for this purpose. Working safely is often difficult in practice. There is always a chance that something will go wrong, and that is what we call risk. The definition of risk is as follows:

**Risk is the degree of probability that a certain undesirable effect will occur.**

**In summary: Risk = Probability x Effect.**

The law requires employers to carry out a risk analysis, the so-called RI&E, with the assistance of one or more expert employees. If an employer does not have any or enough of these employees, external experts must be hired for this purpose. This written analysis focuses on two main points:

- The degree of probability (the chance) that an accident will or could occur.
- The consequences of the accident, should it occur, in the short and/or long term.

During the risk analysis, the expert investigators identify the risks in the workplace and assess them on the following points:

- *Nature of the work;*  
Office workers run different risks than transport workers.
- *Training;*  
Employees without the right training are at greater risk than those with the right training.
- *Workplace;*  
Employees must not be able to stumble or slip easily.
- *Well-being;*  
Employees must be able to enjoy their work.

You have to know the risks before you can do something about them and reduce or even eliminate the risk of an accident. When an unacceptable risk is identified, employers must take measures, such as the following:

- Stop the work and provide instructions: in some cases, employees may be unaware that they are doing something wrong.
- Modifying the unsafe workplace;
- Training employees;  
Providing proper instructions reduces the likelihood that an accident will happen.

This results in reduced risk. Reducing risk is in the employer's and the employee's best interest, which is why the RI&E and the associated Action Plan must be known to the employees concerned.

---

i

#### **NOTE**

**The Action Plan indicates what will be done to address any remaining problems and when this will happen.**

Every year, a written evaluation must show whether the current workplace situation still corresponds to the RI&E and Action Plan. Because the RI&E is the source document for the OHS policy, it must be assessed by certified experts. Employees are permitted to do so themselves, provided they have certified experts or an internal OHS service at their disposal. In other situations, they must call in external certified experts.

As of 1 April 2012, companies with a maximum of 25 employees need not have their RI&E document inspected, provided that they use a recognised RI&E instrument.

---

i

#### **NOTE**

**Remember that there is a lot you can do to prevent accidents yourself.  
A good approach starts with assessing the risks that go along with your work.**

## 2. Transport equipment & lifting equipment technology

### 21 Introduction

In this chapter, we will discuss the technical aspects of various types of electric pallet trucks and stackers. This information will help you assess what certain types of electric pallet trucks and stackers can and cannot do in practice. Attention is also paid to how cargo can affect stability, as instability often leads to serious accidents.

### 22 Types of electric pallet trucks

#### 221 Hand pallet truck (pallet jack)

Hand pallet trucks are a simple and common piece of equipment used for internal and external transport. When used for external transport, they are first loaded into a lorry. Hand pallet trucks serve to move pallets horizontally over a short distance.



#### 222 The electric hand pallet truck

Electric hand pallet trucks are a simple and common piece of equipment used for internal and external transport. The latest generation of electric hand pallet trucks is equipped with a lithium ion battery, which helps keep them compact and lightweight.



#### 223 Electric pallet truck

An electric pallet truck is a piece of equipment used to move goods horizontally. They are used to carry loads consisting of a pallet stacked with goods. There are two types of electric pallet trucks: with or without a platform for the driver.



#### 224 Electric pallet truck with collapsible platform

Electric pallet trucks with a collapsible platform work just as regular electric pallet trucks. Thanks to the compact dimensions of these trucks, their hinged, upright platform and their excellent manoeuvrability, they can be used in very narrow aisles and confined spaces. Thanks to their compact dimensions, they can even be used inside lorries.





225

### **Electric pallet truck with a fixed platform**

Electric pallet trucks with fixed platforms are designed especially for loading and unloading lorries via ramps. Their angled frame reduces the risk of getting stuck on transitions, slopes and platforms and lets them move quickly and safely on slopes and ramps. The steering is smooth and offers great manoeuvrability in confined spaces.



226

### **Seated electric pallet truck**

Seated electric pallet trucks are very ergonomically sound. These electric pallet trucks are equipped with a padded driver's seat and a height-adjustable footplate. In situations where operators have to traverse long distances, seated pallet trucks can contribute to an ergonomic working space.



23

## **Types of stackers**

231

### **Stacker**

Stackers have support wheels that are placed so close to each other that the forks rest on or hover over the supports when they are in the lowest position. This allows you to place loads perfectly side by side, leaving minimal space in between. A disadvantage of this type of equipment is that it can only be used with single-deck pallets due to its structure, with the forks hovering over the supports. Clearly, the pallets should be aligned vertically, due to the fact that there will be little space between the pallets and the supports. As a result, getting goods in and out of storage requires fairly precise manoeuvring.

232

### **Pedestrian stacker**

The pedestrian stacker is a piece of equipment used to move goods horizontally and vertically. They are used to carry loads consisting of a pallet stacked with goods. These stackers are also very suitable for working in confined spaces.



233

### **Stacker with collapsible platform**

Stackers with a collapsible platform work just as regular stackers. Thanks to the compact dimensions of these trucks, their hinged, upright platform and their excellent manoeuvrability, they can be used in very narrow aisles and confined spaces. Thanks to the platform, operators can use these stackers to safely and ergonomically traverse long distances.



234

### Seated stacker

Seated stackers are very ergonomically sound. These stackers are equipped with a padded driver's seat and a height-adjustable footplate. In situations where operators have to traverse long distances, seated stackers can contribute to an ergonomic working space.



235

### Pedestrian stacker with inclining mast

Pedestrian stackers with an inclining mast are more versatile than standard stackers. Not only can the mast be inclined, but the width of the forks can also be adjusted. It is also possible to mount attachments to these stackers.



236

### Wide gauge stacker

The support legs of wide gauge stackers are so far apart that loads fit in between them. For proper stacking, the space between stacks must be wider than the stacker's support legs.

This will result in an extra loss of space, in addition to the standard spacing between stacks. On top of that, the space between the support legs determines the maximum permissible load width. A major advantage, however, is that wide support legs contribute to greater stability.



24

### Instrument panel

The instrument panel or dashboard of an electric pallet truck or stacker provides the operator with information on the technical condition of the vehicle. The instrument panel will contain an hour meter and a battery gauge, but can also be used to change certain settings, e.g. switching between different operating modes. In some cases, the display may even show the weight of the load.



## The wheels

Tyres are very important for electric pallet trucks and stackers, as they have to bear the weight of both the vehicle and the load. The following requirements are particularly important:

- Load capacity
- Driving comfort
- Rolling resistance
- Grip
- Suspension

(stability)  
(indoor or outdoor use) (floor)  
(indoor or outdoor use)  
(floor, indoors or outdoors)

Generally speaking, three types of tyres are found on material-handling equipment:

- Pneumatic tyres
- Airless tyres
- Solid tyres



Electric pallet trucks and stackers only have solid tyres, because they are mainly used indoors and on flat surfaces.

### Solid tyres

Electric pallet trucks and stackers are equipped with solid tyres. On flat floors, such as in warehouses, solid tyres are easy to use. These tyres have a high load-bearing capacity and a long service life and they are sometimes used on larger, heavier forklifts.

#### Advantages:

- + Stable
- + No maintenance
- + Low overall height
- + Cannot be punctured

#### Disadvantages:

- Zero springiness
- High pressure on floor



## Overhead guard

To protect the operator from falling objects, electric pallet trucks and stackers have an overhead guard. All material-handling equipment that can lift cargo above a height of 1.80 m is required to have an overhead guard, with the exception of stackers. Stackers that are not equipped with an overhead guard must have a load backrest.



### **WARNING**

**A faulty protective guard on a stacker, falling loads, or tipping can put the operator in a potentially life-threatening situation.**

Welding or drilling performed on the overhead guard change its material properties and structural design. When the guard is subjected to heavy loads due to falling cargo or tilting, the modified guard may buckle, at which point it will no longer protect the operator.

In order to guarantee the stability of the protective guard at any rate, no modifications may be made to the guard unless the manufacturer has tested and approved the new design.

## Mast

The mast of a stacker consists of two or more mast sections. Masts are designed to extend in order to lift the carriage, as a hydraulic cylinder pushes the various sections of the mast up. Depending on the desired lift height, masts come in the following types:

- duplex mast with 1 extendible section
- triplex mast with 2 extendible sections

The advantage of a triplex mast is a higher max. lift height at a low overall height. However, visibility to the front is often limited by the lifting cylinder and stability decreases as the mast is extended. To improve the operator's forward visibility, the central lift cylinder can be replaced by two cylinders placed side by side, allowing for better forward visibility. We call this a "see-through mast".



**WARNING**

The stability of material-handling equipment decreases as the mast is extended.



duplex mast with  
1 extendible section



triplex mast with  
2 extendible sections

## Fork carriage and lifting chain

As standard, stackers are equipped with a fork carriage with two forks. This fork carriage is moved up and down the mast by a mechanism consisting of rollers, the lifting chain and the lifting cylinder. When material-handling equipment is used to lift loads made up of individual parts, a load backrest must be mounted on the fork carriage.

## Attachments

Stackers can be equipped with a fork carriage with adjustable forks, which can be substituted for other attachments. Attachments have an important feature: they make it easier to pick up and move “special cargo”. With and without a load, attachments have a significant positive and negative impact on the various characteristics of a piece of material-handling equipment.

### Pro:

- + Easier to move specific types of cargo.

### Con:

- The weight of the attachment usually decreases overall lifting capacity. Due to the way attachments are typically designed and manufactured, they usually increase the distance between the load and the front axle.

When a piece of material-handling equipment is fitted with an attachment, this must be specified on the nameplate or on the load chart. In addition, attachments must have a nameplate detailing the necessary information.

### The most common attachments

Attachments come in a wide range of different types and versions. We will briefly discuss the most common types below.

### Side-shift

This hydraulic attachment can be used to hydraulically manoeuvre the fork carriage horizontally by 10 to 15 cm. On reach trucks, this attachment can be used to move the entire mast to the left or right.

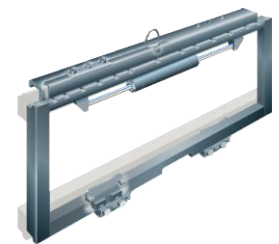

### Extension forks

Long loads require long forks. To carry long loads, you can use extension forks that can easily be fitted to the fork carriage.



29.3

### Reach forks

Reach forks are hydraulically extendible and retractable, allowing for double-deep stacking, which can be especially handy when loading or unloading a lorry from the side. Please keep in mind that this attachment does significantly increase the distance from the centre of gravity, which we will address in further detail later on in this chapter.



29.4

### Hydraulic fork positioner

This attachment can be used to hydraulically adjust the width of the forks. This is especially useful when transporting pallets of different sizes.



29.5

### Mandrels

Mandrels are often used for loads that have an aperture in the middle, such as tires, coils of wire, carpeting or concrete pipes. It can be mounted in the middle of the fork carriage, replacing the forks.

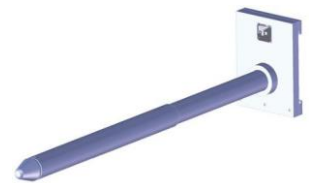

29.6

### Tilter (rotating device)

This attachment makes it possible to hydraulically rotate the fork carriage and forks by 180° or 360° in both directions, making it easier to tilt pallets or transport containers.



29.7

### Push pull

A slip sheet, a sturdy sheet of cardboard or plastic, can be used to transport goods without using pallets. The push pull consists of a frame that is shifted hydraulically. Below the frame is a wide, hydraulic clamp that clamps the upright edge of the slip sheet. Retracting the frame pulls the slip sheet onto the forks. Extending the frame, pushes the slip sheet from the forks.

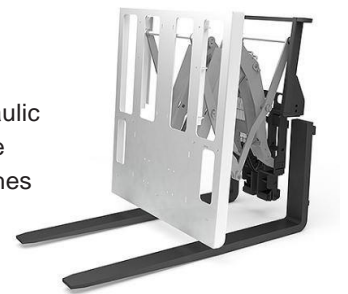

29.8

### Roll clamps

Roll clamps are used to clamp rolls of paper, for instance, so that they can be transported without pallets. Bale, box and stone clamps also exist.



2.9.9

### **Mechanical drum clamp (parrot beak)**

The gripping head clamps drums by the lip. When picking up a drum, the gripping head grips the lip of the drum from below and closes automatically when the drum is lifted up. During transport, the wall of the drum rests against the curved support beam that is part of the attachment. When the drum is put down, the clamp opens automatically.



2.9.10

### **Lifting jib**

A lifting jib is a lifting device consisting of a beam with a hoist ring at the top and in the middle. Lifting jibs are used to move odd-sized loads. Before you start working with a lifting jib and lifting belts, it is recommended to follow an additional training course on securing loads.



2.10

### **Brakes**

All material-handling equipment is equipped with a service brake. This is done hydraulically by means of a pedal and electronically by releasing the accelerator or direction switch.

2.10.1

### **Service brake**

When the travel direction switch on an electric pallet truck or stacker is released and it returns to neutral, the machine will automatically brake. When the travel direction switch is changed to the opposite direction, the truck will also brake. Please note that in the latter case, the truck will automatically start driving in the opposite direction once it has slowed down enough.



### Parking brake

The parking brake on electric pallet trucks and stackers works differently than on a forklift or reach truck. When the tiller is released, it will return to its neutral position. When the tiller returns to its neutral position, the electromagnetic safety brake, also known as the parking brake, is activated.



### Steering system

To steer an electric pallet truck or stacker, you use the drive wheel, rather than the rear wheels. Nowadays, all electric pallet trucks and stackers have power steering. In order to prevent damage to the steering system and wear & tear on the tyres, it is important to move the tiller back and forth as little as possible while the vehicle is stationary.

#### Manoeuvrability

This determines how easily an electric pallet truck or stacker can turn and depends on various factors:

- The turning radius of the vehicle
- Width and depth of the load
- With or without a platform
- Aisle width

## 212

### **The lifting mechanism**

The most important feature of a stacker is its lifting mechanism. This hydraulic mechanism is used for the following functions:

- Lifting the mast
- Tilting the mast (forward or backward)
- Attachments (e.g. side shift)

## 2121

### **Pressure relief valve or overflow valve**

When picking up too heavy a load or upon reaching maximum extension, overpressure occurs in the system, which means the pressure in the pipelines and cylinders is too high. The hydraulic system usually features a pressure relief valve for protection. In case of overpressure, this valve will allow oil to flow back to the tank, while ensuring the pressure in the cylinders remains the same.

## 2122

### **Lowering safety valve or lowering limiter**

If the pressure in the lifting mechanism is lost due to a broken pipe or hose, the lowering safety valve causes the forks (with or without load) to descend slowly and gradually. Without this limiter, the load would fall down at a high speed.

## 213

### **Key concepts**

When describing material-transport equipment, we distinguish between five different heights:

- Lowered fork height
- Drive height
- Lift height
- Free lift height
- Reach height

## 2131

### **Lowered fork height**

The lowered fork height is the distance from the floor to the highest point of the stacker with the mast in vertical position and the forks on the floor.

## 2132

### **Drive height**

The drive height is the distance from the floor to the highest point of the stacker with the mast tilted backwards and with the heels of the forks 10 - 15 cm above the floor (driving position).

2133

### Lift height

Lift height is the maximum height the forks can reach when the mast is fully extended and in vertical position, measured from the floor to the top of the forks. The lift height is also indicated on the nameplate of the stacker.

2134

### Free lift height

The free lift height is the distance from the top of the fork to the floor, without extending the mast or changing the height of the stacker. Different stackers have different free lift heights. In spaces with low ceilings, such as wagons or containers, greater free lift heights are particularly convenient.

2135

### Reach height

As opposed to lift height, reach height depends on various factors:

- The height of the pallet
- It must be possible to lift the pallet slightly
- Tyre wear and tyre pressure

*In general, the difference between lift height and reach height is taken to be about 25 cm. This means that if a piece of material-handling equipment has a lift height of 5 metres, its reach height is  $5\text{ m} - 0.25\text{ m} = 4.75\text{ m}$ .*

2136

### Lifting capacity

The lifting capacity or load capacity of an electric pallet truck or stacker is the maximum weight that the vehicle can safely lift. In practice, a vehicle's lifting capacity can be reduced greatly by increasing the distance from the centre of gravity, increasing the lift height with a longer mast and by using attachments. Lifting capacity can always be found on a forklift or reach truck's nameplate.

## Stability

Stability, or rather instability, causes a large number of accidents resulting in bodily injury or, even worse, death every year. There are a number of factors that can cause a piece of material-handling equipment to tip over:

- A heavy load
- A heavy load at height
- The load centre is too great
- Lifting a load with the mast tilted forwards
- The load's centre of gravity is not aligned with the centreline
- Driving while lifting a load
- Overly quick cornering



The first six factors have an adverse effect on the stability of the electric pallet truck or stacker, with or without load, due to the so-called lever effect. These factors will be discussed and explained later. The final two factors are related to adverse forces caused by driving the electric pallet truck or stacker at a certain speed.

Before picking up a load with an electric pallet truck or stacker, you must be certain that the load is within the vehicle's lifting capacity. You can find a vehicle's lifting capacity on its nameplate. Load, it is important that you take into account its weight, as well as its dimensions and the vehicle's lift height.

The dimensions, and particularly the depth of the load, determine its centre of gravity. The greater the distance between the centre of gravity and the front axle, the lower the maximum weight of the load. The same applies when lifting loads: The higher you lift a load, the less stable the electric pallet truck or stacker will be.

### Centre of gravity

An object's centre of gravity is the point around which the object's mass is distributed. From this point, the object is in perfect equilibrium. If we add weight to one side, the centre of gravity will move towards the heavier side and move up a bit.

Like all other objects, electric pallet trucks and stackers also have their own centre of gravity. If a stacker is not carrying a load on its forks, for instance, its centre of gravity is between the front axle and rear axle. When a stacker is carrying a load, its centre of gravity moves forward, towards the tipping point, or the front axle. If the weight of the load is equal to the stacker's lifting capacity, but its centre of gravity is too far from the forklift, it will cause the stacker to tilt forward.

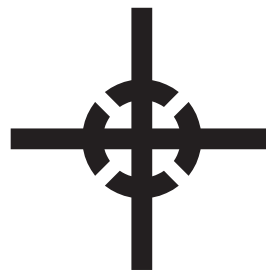

Centre of gravity

### Load centre

The load centre is the distance from the heel of the fork to the load's centre of gravity. The load centre, maximum load weight and lift heights are calculated by the manufacturer and incorporated in a load chart.

i

#### EXAMPLE

**If a stacker has a lifting capacity of 1600 kg and a load centre of 50 cm, can it transport a 1600 kg load with a depth of 100 cm?**

**If the load's centre of gravity is at 50 cm, this is fine. If the load's centre of gravity is equal to the stacker's load centre, the maximum load weight is equal to the specified lifting capacity.**

First, though, we have to know what a centre of gravity is.

**EXAMPLE**

Take a 100 x 100 cm pallet. Its centre of gravity is located at 50 cm, because  $100 / 2 = 50$  cm. The depth of a pallet determines the load centre. This theory only applies if the pallet is loaded uniformly. In practice, matters can be very different.

A 120 cm x 100 cm pallet can have a load centre of 50 cm or 60 cm, depending on which side of the pallet faces the forklift.

Given the load centre of a particular pallet, it is easy to find its depth. After all, the theory states that the centre of gravity is always in the middle. With a load distance of 50 cm, the pallet depth must be:  $50 \text{ cm} \times 2 = 100 \text{ cm}$ .

**214****Load chart**

Because it is very difficult for operators to estimate how a load will affect the stability of their electric pallet truck or stacker in practice, manufacturers have to draw up load charts. These load charts must be affixed to the vehicle so that they are visible to the operator. The load chart specifies load centres, as well as the corresponding weights and lift heights.

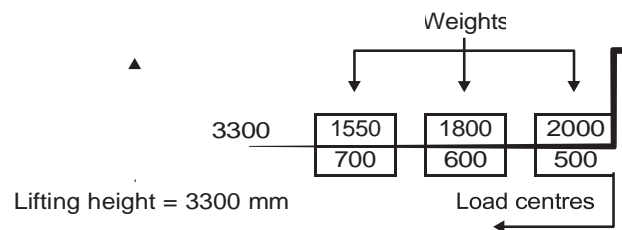

The above load chart must be read as follows:

<b>Load centre:</b>	<b>Lifting capacity (weight):</b>	<b>Lift height:</b>
500 mm	2000 kg	3300 mm
600 mm	1800 kg	3300 mm
700 mm	1550 kg	3300 mm

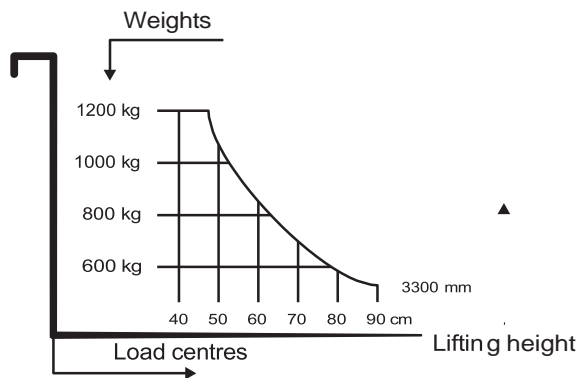

The above load chart must be read as follows:

Load centre:	Lifting capacity (weight):	Lift height:
40 cm	1200 kg	3300 mm
60 cm	825 kg	3300 mm
90 cm	500 kg	3300 mm

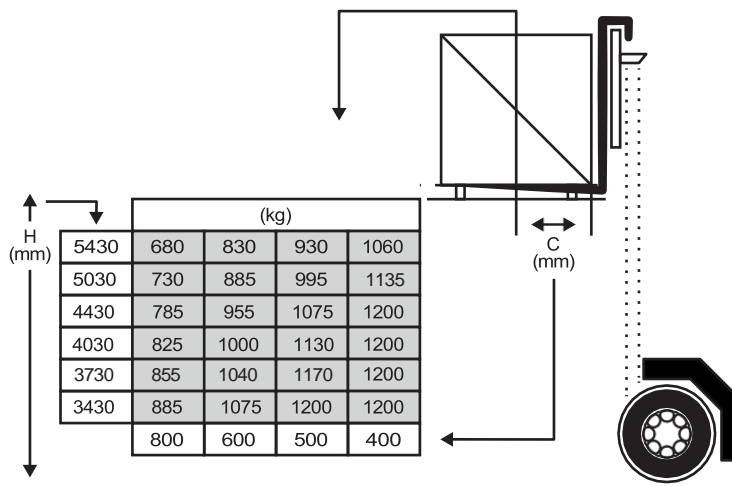

The above load chart must be read as follows:

Load centre:	Lifting capacity (weight):	Lift height:
400 mm	1200 kg	4430 mm
500 mm	1200 kg	3430 mm
600 mm	1000 kg	4030 mm
800 mm	680 kg	5430 mm

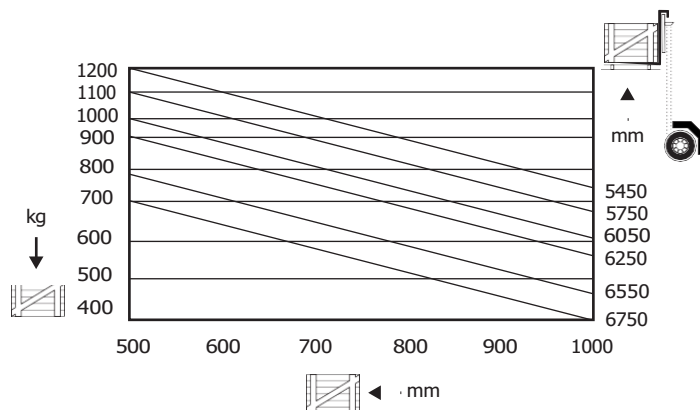

The above load chart must be read as follows:

<b>Load centre:</b>	<b>Lifting capacity (weight):</b>	<b>Lift height:</b>
500 mm	1200 kg	5450 mm
600 mm	870 kg	6050 mm
800 mm	500 kg	6750 mm
1000 mm	520 kg	6250 mm

These examples show that the following information is of great importance when lifting loads:

- The load centre
- The lift height
- The weight of the load

## 215

### Shifted centre of gravity

The operator must always strive to centre the load as much as possible. In practice, this will usually mean that the load's centre of gravity should be in the middle of the forks. In case of odd-shaped loads with an off-centre centre of gravity, the load must be picked up so as to position its centre of gravity in line with the centreline of the forklift. If the load's centre of gravity is not aligned with the forklift's centreline, the load on the forklift will be uneven and the risk of tipping will increase.

## 216

### Equipment weight

Due to its compact design, the weight of electric pallet trucks or stackers is often underestimated. To find out the correct weight, look at the nameplate. Manufacturers are obliged to state the weight of the vehicle on the nameplate. For electrically powered vehicles, remember to add the weight of the battery to the vehicle's empty weight.



# 3. Propulsion mechanisms and technical components

## 3.1 Introduction

Electric pallet trucks and stackers are always powered by an electric motor and a traction battery or lithium battery.

## 3.2 Electric motor

Electric motors not only power the machine-handling equipment, but also the oil pump and power steering system. Electric motors are powered by a traction battery.

## 3.2.1 Advantages and disadvantages of electric vehicles

### Advantages:

- + Clean
- + Quiet
- + Can be used in the food industry

### Disadvantages:

- Charger needed
- Expensive, fragile battery
- Charging area needed
- Quiet



## 3.3 Traction battery

Traction batteries convert chemical energy into electrical energy and consist of 2-volt power cells. The number of cells in the battery determine its capacity. These cells are filled with lead and sulphuric acid, a highly corrosive liquid.

## 3.3.1 Charging the traction battery

Charging traction batteries is important, because when they are not used until empty, their technical service life is shortened significantly. In addition, their capacity will decrease, as they become “lazy”.

Traction batteries should preferably be recharged when they only have 10% charge left. The most accurate way to measure the charge status of a traction battery is with the aid of an acid weigher, which is used to measure the specific gravity (s.g.) of the liquid inside the battery.

### Charging area

Traction batteries should be charged in rooms or areas without any naked flames and other potential sources of sparks, e.g. welding and grinding, are also strictly forbidden.

When a traction battery is recharged, the liquid inside it is set in motion, producing hydrogen gas. Hydrogen is highly explosive and one spark is all it takes to cause an explosion. Hydrogen levels of 4% and higher present an explosion hazard. Therefore, the charging area must be well ventilated and meet all requirements set by the government.



At least the following materials must be present in the charging area:

- Bottle of eyewash or eye bath
- Fire extinguisher;
- Extraction unit;
- PPE;
- Absorption granules;
- Soda



#### **PLEASE NOTE**

**Neutralise any liquid spills with soda.**

When working on the traction battery, use the appropriate personal protective equipment:

- Acid-resistant glasses or face mask
- Acid-resistant gloves
- Acid-resistant apron



#### **PLEASE NOTE**

**Always wear long-sleeved clothing when working with a traction battery.**

### Weighing acid

As the battery charges and discharges, the specific gravity (grams per cm<sup>3</sup>) of the liquid within it will increase or decrease. The particle density of the liquid increases when the battery is charged, so the liquid becomes “heavier”). You can measure the specific gravity of the liquid with an acid weigher. There is a scale on the stem of the float, on which you can find the specific gravity. Measuring the specific gravity of the liquid inside a traction battery lets you determine its remaining charge. In other words: it indicates whether the battery needs to be charged or not.

### Tiller

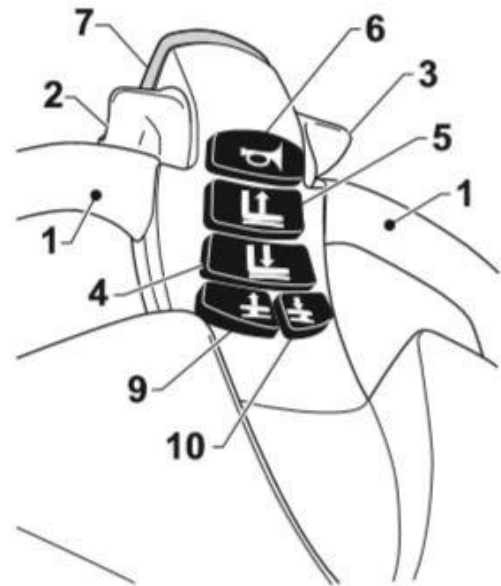
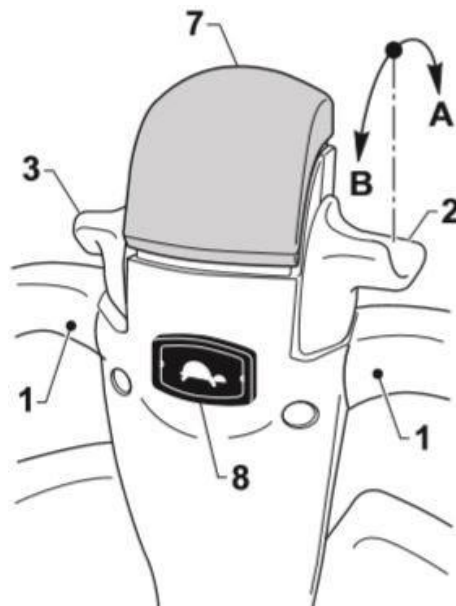

1. Tiller handle
2. Front and reverse switch
3. Front and reverse switch
4. Lower forks
5. Raise forks

6. Horn
7. Safety reverse switch (deadman's switch)
8. Low speed button (Creep Speed)
9. Initial raise button (only for special equipment)
10. Initial raise button (only for special equipment)

## 1 Tiller handle

- Holds the tiller head while the machine is being operated.

## 2/3 Front and reverse switch

- When the drive switch (2 or 3) is moved in the direction (A), the machine will start moving in the direction of the forks.
- When the drive switch (2 or 3) is moved in the direction (B), the machine will start to move in the direction of the driver.
- The speed of the machine is proportional to the angle of the drive switch.
- Releasing the drive switch activates the brakes, which will stop the machine.

## 4 Lower forks

- Press this button (4) to lower the forks.
- The forks can be halted at any time by releasing the button (4).  
The forks will stay where they are.
- The 'Lower forks' button (4) can only be activated when the tiller is in work mode.

## 5 Raise forks

- Press this button (5) to raise the forks up to their maximum height.
- The forks can be halted at any time by releasing the button (5).  
The forks will stay where they are.
- The 'Raise forks' button (5) can only be activated when the tiller is in work mode.

## 6 Horn

- Press this button (6) to sound the horn. The operator can use the horn to make their presence known, if necessary.

## 7 Safety reverse switch (deadman's switch)

- Press the button (7) while the machine is moving in the direction of the driver to automatically change direction. During this change, the machine's speed will be reduced for a few seconds.
- This button is a safety device. It is particularly useful when working in confined spaces, as it prevents the operator from getting trapped between a wall and the tiller head.
- The machine automatically changes direction when the button (7) comes into contact with the operator's body. When the driver moves away and releases the button (7), the machine stops.



## 8 Low speed button (Creep Speed)

- This button (8) activates the optional 'Creep Speed' mode.
- Holding down the button (8) and simultaneously turning the travel switch (2-3), activates Creep Speed mode regardless of the position of the tiller.
- When the button (8) and the raise forks button (5) are pressed at the same time, the forks are lifted regardless of the position of the tiller.



### 9 Initial raise button (only for special equipment)

- Press the button (9) to raise the support arms; as soon as you release the button, the support arms will stop in their current position.
- The 'Raise supports' button (4) can only be activated when the tiller is in work mode.

### 10 Knop initiële heffing (alleen bij speciale uitrusting)

- Press the button (10) to raise the support arms; as soon as you release the button, the support arms will stop in their current position.
- The 'Raise supports' button (4) can only be activated when the tiller is in work mode.

341

### Example of initial raising

Initial raising means that the support legs can be raised separately from the fork carriage, as shown in the example below:



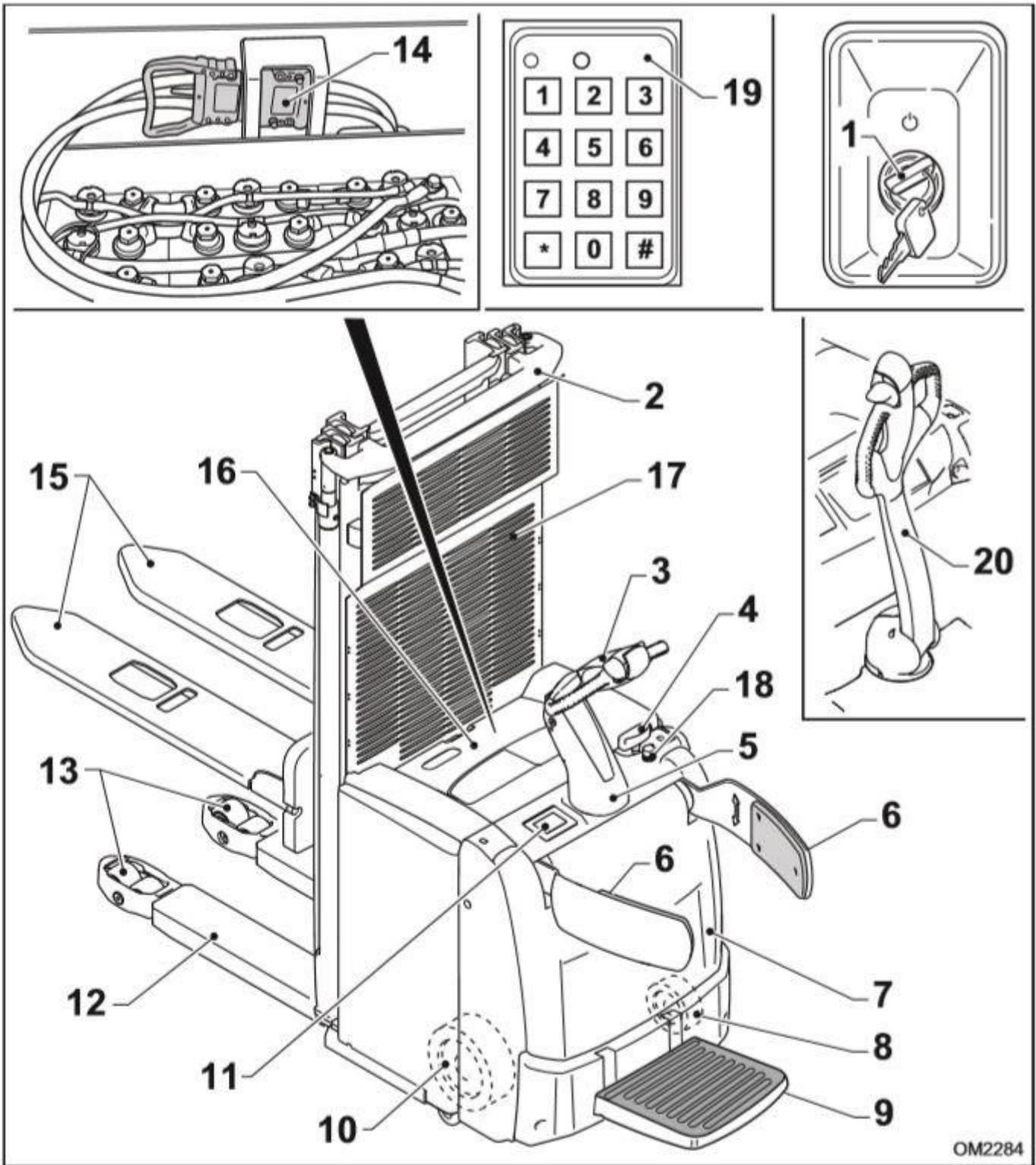

- |                               |                         |
|-------------------------------|-------------------------|
| 1. Ignition                   | 11. Display             |
| 2. Mast                       | 12. Support arms        |
| 3. Tiller head                | 13. Load rollers        |
| 4. Emergency stop lever       | 14. Battery plug        |
| 5. Tiller                     | 15. Forks               |
| 6. Side protection for driver | 16. Battery cover       |
| 7. Motor cover                | 17. Slide protection    |
| 8. Swivel castor              | 18. Diagnosis connector |
| 9. Driver platform            | 19. Numeric keypad      |
| 10. Drive wheel               | 20. Tiller              |

### Emergency stop

- Button (4) is the emergency stop button.
- Pressing the emergency stop button automatically blocks all machine functions.



# 4. Transport & storage equipment

41

## Introduction

In many companies, goods are transported and stored. To make sure that goods are processed properly, it is important to make the right choices in terms of pallets (stacking equipment), storage - such as racking - (storage equipment) and transport (material-handling equipment). When these factors are properly taken into account, the work will generally become much safer and more efficient.

### Carefulness

Exercising due care when transporting and storing goods minimises the risk of damaging the goods, as well as the buildings, machines and installations along the transport routes.

### Safety

Safe transport and storage prevent injury to people tasked with transporting goods, as well as people who may be in the vicinity of transport routes or work in storage areas.

### Effectiveness

Effective transport and storage can be achieved:

- by keeping the transport routes as short and logical as possible;
- making the best possible use of the available storage space;
- the correct selection and use of the available transport equipment.

42

## Pallets

A pallet is a platform with openings on the sides that make them easier to lift with material-handling equipment. Pallets are often used to pack a number of loose goods to form a "unit load".

421

## Pallet dimensions

Pallets are available in different types and sizes. Choosing the right pallet comes down to several factors such as load type, load weight, storage method, mode of transport and the customer's wishes.

A few examples:

- 120 cm x 100 cm      standard pallet;
- 120 cm x 80 cm      euro pallet;
- 60 cm x 40 cm      display pallet;
- 60 cm x 80 cm      display pallet;
- 60 cm x 100 cm      display pallet.



## **4.3 Pallet types**

### **4.3.1 Two-way or four-way pallets**

The advantage of a four-way pallet is that it can be lifted from all sides.

### **4.3.2 Single-use and durable pallets**

Single-use pallets are usually lightweight, because they are meant to be used only once. Single-use pallets are also known as disposable pallets, and they are used when there is no pallet return scheme in place.

Durable pallets are considerably stronger. These pallets are often returned and recycled so that they can be reused several times.

### **4.3.3 Single deck or double deck**

In addition to the types mentioned above, a distinction can also be made between single-deck and double-deck pallets. Single-deck pallets only have a single platform or deck. Double-deck pallets have two platforms: one at the top and one at the bottom. Double-deck pallets are sturdy, but they are also heavy. One of the drawbacks of double-deck pallets is that they cannot always be lifted with a pallet jack or electric pallet truck.

## **4.4 Pallet materials**

Wood, metal, plastic or cardboard? Choosing the right material for a pallet depends strongly on how and where it will be used. In the food industry, for instance, pallet materials have to meet different criteria than in the metal industry.

### **4.4.1 Wooden pallets**

Most pallets are made of wood. This material is generally the best. Wooden pallets are generally lightweight, reasonably sturdy and low-cost. Wooden pallets are also easy to repair, which is one of the reasons why they have a reasonably long lifespan.

### **4.4.2 Metal pallets**

Metal pallets are suitable for heavy loads and can last a long time. On the other hand, they have the disadvantage of being more expensive and heavier than wooden pallets. Another disadvantage of metal pallets is that they are more prone to sliding while being transported on forks. After all, there is less friction between metal and metal than between metal and wood.

### **4.4.3 Plastic pallets**

Plastic pallets are relatively lightweight and highly resistant to external factors, such as rain, chemicals or acids. Another advantage of plastic pallets is that they are easy to clean (food industry). Disadvantages of plastic pallets are their high cost, that they cannot be repaired when broken and that they can easily slide off lifting forks in damp and wet environments.

444

### **Cardboard pallets**

Cardboard pallets are light, inexpensive and suitable for one-way transport of light items under dry conditions.

45

### **Pallet configurations**

Until now, we have been talking about flat pallets, without a special configuration. Because all sorts of goods require transport, various special pallet configurations have also been developed.

45.1

#### **Flat pallets**

These pallets are used for goods that are easy to stack, such as boxes.

45.2

#### **Collared pallets**

This pallet configuration makes it easier to transport small, individual items. Pallet collars come in many different shapes and sizes. An added advantage of a collar is that it makes it easier to stack several pallets on top of each other without damaging the goods on the bottom pallet.

45.3

#### **Drum pallets**

Drums are difficult to pick up or put away with a forklift. A special barrel pallet has been developed for this purpose that was designed specifically to store two drums next to each other. These pallets feature recesses so that they can be lifted on a fork.

4.6

### **Securing loads**







In addition to choosing the right type of pallet, loading the pallet correctly is of great importance in order to guarantee good, safe transport. Pallets loaded with boxes or bags can often be stacked in an overlapping brick pattern, just like a brick wall.

If the load cannot be stacked in a brick pattern, it can be secured in other ways, such as:

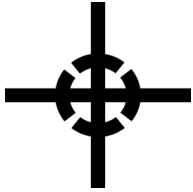
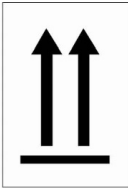
- wrapping the load in shrink film;
- securing the load with adhesive tape or with plastic or metal straps;
- placing a cardboard insert between layers to increase stability.

## Handling labels

When moving and securing loads, you must take the following labels into account.

- |    |   |    |   |    |   |    |   |
|----|---|----|---|----|---|----|---|
| 1. |  | 2. |  | 3. |  | 4. |  |
|    | Centre of gravity<br>indication   |    | This side<br>up   |    | Fragile   |    | Keep dry  |
| 5. |  | 6. |  | 7. |  |    |   |
|    | Do not<br>stack   |    | Do not<br>allow to<br>defrost   |    | Keep away<br>from heat  |    |   |

## 4.7

### Labels

Packaging containing hazardous substances is labelled. These labels provide information on the potential hazards of the substance in question. They have a warning function and are of great importance to everyone involved in the transport of such goods. Emergency service providers can also refer to this information in the event of an accident.

Operators of material-handling equipment who work with hazardous substances must also observe various rules.

- Smoking is prohibited when working with hazardous substances;
- Eating and drinking is prohibited in areas with hazardous substances;
- They must have any wounds treated immediately.

i

#### NOTE

**When transporting hazardous substances, drive backwards to prevent the load from sliding off the forks if you have to brake suddenly.**

#### 4.7.1

#### Labelling of hazardous substances (old and new)

All around the world, we have agreed to start classifying and labelling chemicals the same way. This agreement is also known as the Globally Harmonized System, or GHS for short.

With the introduction of the GHS, the familiar orange hazard symbols and corresponding risk phrases (R-phrases) and safety phrases (S-phrases) disappeared.

They have been replaced by new pictograms, new hazard phrases (H-phrases) and precautionary measures (P-phrases).

The GHS has been in force in Europe since 2009, though an initial transition period applied until 2015. Chemical products with an old label could be sold until June 2017.

The 'old' labelling rules came from the Dutch Environmentally Hazardous Substances Act. This law has since been abolished. The enforcement of the GHS is now regulated by the Environmental Management Act.

The next page shows a simplified overview of the old and new pictograms. For a more detailed overview, including a breakdown of the hazard classes and categories used, as well as a list of H-phrases, please refer to the from WMS to EUGHS overview.

Old pictogram	New pictogram
 <p data-bbox="608 369 683 392">Explosive</p>	 <p data-bbox="959 369 1038 392">Explosive</p>
 <p data-bbox="608 548 683 571">Oxidising</p>	 <p data-bbox="959 548 1038 571">Oxidising</p>
 <p data-bbox="608 728 683 750">Flammable</p>	 <p data-bbox="959 728 1038 750">Flammable</p>
 <p data-bbox="608 907 683 929">Harmful</p>	 <p data-bbox="938 907 1054 929">Irritant/harmful</p>
 <p data-bbox="608 1086 683 1108">Corrosive</p>	 <p data-bbox="959 1086 1038 1108">Corrosive</p>
 <p data-bbox="608 1265 683 1288">Toxic</p>	 <p data-bbox="959 1265 1038 1288">Toxic</p>
 <p data-bbox="560 1444 730 1467">Environmental hazard</p>	 <p data-bbox="852 1444 1134 1467">Hazardous to the aquatic environment</p>
	 <p data-bbox="927 1624 1070 1646">Gas under pressure</p>
	 <p data-bbox="943 1803 1050 1825">Health hazard</p>

## 4.8 Storage equipment

### 4.8.1 Cold stacking

Cold stacking involves stacking goods or pallets directly on top of each other, making optimum use of the available space. Please note that not all goods may be stacked equally high.

### 4.8.2 Racking

Goods can also be stored in racks, which come in many shapes and sizes. Racking has to comply with a wide range of safety requirements (e.g. horizontal beams must be properly secured) and must feature a nameplate showing, among other things, its load-bearing capacity. Warehouse racking must be inspected by a competent person at least once a year. (NEN-EN 15635)

#### Pallet racks

Pallet racks are made up of uprights and horizontal beams. The space between two uprights is called a section. These sections are subdivided into locations: spots for pallets.

#### Drive-in racking

Drive-in racking is also made of uprights and horizontal beams. However, these elements are connected in such a way that pallets can be stored several rows deep. Drive-in racking is mainly used for storing a large quantity of the same goods. The advantage of drive-in racking is that it can accommodate a large number of pallets with a limited number of aisles.

#### Cantilever racking

Cantilever racking is made of uprights and load-bearing arms. Because there are no sections in cantilever racking, they are especially suitable for long materials.

## 4.9 Loading and unloading equipment

You can use the following equipment to load or unload a lorry:

Loading platform



Dock leveler



Lifting table



Mobile loading dock



## 4.10 **Damage to pallets**

Damage to pallets has both a direct and negative impact on production, internal transport and storage.

Damaged pallets:

- Hamper the rapid flow of goods;
- Endanger people's safety (e.g. when a stack topples over);
- Can damage the product;
- Have to be replaced, which can be expensive;
- Increase costs due to the time lost repackaging loads.

Damage can be caused by;

### 4.101 **Incorrect mast tilt**

When working with a pallet, make sure that the forks are horizontal.

### 4.102 **Overly long forks**

When working with smaller pallets, the forks may protrude and damage the load behind them.

### 4.103 **Overly short forks**

If the forks are too short, point loads are created which can damage the pallet or load.

### 4.104 **Poor fork spacing**

If the forks are spaced too closely together or too far apart, pallets may sag.

### 4.105 **Not fully retracting the fork from the pallet**

Make sure that the forks have cleared the pallet before turning the vehicle.

### 4.106 **Sliding pallets**

Sliding pallets are a common cause of damage.

### 4.107 **Fork height while driving**

If the forks and pallet are not lifted high enough when driving, the pallet can be damaged. Make sure to keep potential height differences in mind.

### 4.108 **Leave plenty of room**

Make sure that you always have plenty of room when putting down a pallet.



#### **CAUTION**

**Do not use damaged pallets. It is best to throw them away.**

# 5. Safety

## 5.1

### Introduction

Electric pallet trucks and stackers play an important role in the transport of goods. Despite the risks associated with the incorrect use of electric pallet trucks and stackers, working with these vehicles is no more dangerous than working with any other machine or piece of equipment. The only condition is that operators are aware of all the safety rules and apply them. Before you start working with electric pallet trucks and stackers, make sure you are familiar with the manual and operating instructions and never use equipment for anything other than its intended use.

Accidents can happen anywhere and are either the result of human error or technical failure. If we were to set the total number of failures and errors at 100%, technical failures would be at fault for 5% of accidents, with the other 95% being caused by human error. The most common accidents are entrapment, knocks and collisions. These accidents often result in injuries. Hands, feet, arms and legs are the most commonly affected parts of the body.

Many accidents are the result of high workloads, unclear traffic rules and failure to comply with the rules. (see [www.cgvm.nl](http://www.cgvm.nl))

Common occupational diseases such as back, neck and joint problems can also be prevented by taking various ergonomic and behavioural measures, such as:

- Correct sitting posture (seat position and steering wheel setup)
- Not jumping from equipment (use the steps and brackets)
- Correct driving behaviour (no unnecessary reversing)
- Using the right workwear

#### **NOTE**

**There is no such thing as total safety!**

**Working safely means consciously taking acceptable risks.**



## Company regulations

Employees must be familiar with company regulations, and these rules also apply to all persons present on the company premises and in the building. It is important to know:

- Where to find fire extinguishers and how to use them if necessary
- Where to find the first-aid kit
- Where the escape routes are
- Who should be alerted in emergency situations
- Whether hazardous substances are present
- What the company's traffic rules are

i

### NOTE

**In the event of an accident, you must first ensure your own safety before taking any action.**

## User requirements

Employees who operate material-handling equipment, such as electric pallet trucks, stackers and forklifts, need to have specific expertise. Operators must have:

- The mental and physical ability to operate the vehicle
- Technical skills
- The ability to recognize hazards

### Safety requirements

In order to work **independently** with an electric pallet truck or stacker, operators must be 18 years of age. Persons aged 16 and 17 may only drive under expert supervision.

Which Personal Protective Equipment (PPE) is prescribed depends on the work situation and company regulations. **In any case, operators of electric pallet trucks and stackers, employees and third parties are obliged to wear safety shoes in all areas where electric pallet trucks and stackers is used.** It is the employer's responsibility to make sure that this rule is observed.

When working with an electric pallet truck or stacker without a platform, it is important to keep sufficient distance from the machine. It is important to keep at least 1 metre clear from the machine while operating it. If this is not possible, walk next to the machine. Heel collisions are a common injury with these machines and are a perfect illustration of why it is important to stay at a safe distance from the machine while operating it.

## **5.4 Truck inspection**

Before we start using an electric pallet truck or stacker, we must check whether it is in working order. Any faults or defects must be reported, and if there are any defects that compromise safety, we must not use the vehicle at all. What to check:

### **5.4.1 Forks/Fork carriage**

- Are the forks centred and secured to the fork carriage
- Are there any cracks in the heels of the forks
- Are the locking bolts present
- Are the guide rollers in working order
- Is the load backrest securely attached and free from damage?

### **5.4.2 Mast and lifting chains**

- Is there any wear and tear or are there any defects
- Is the chain guide working properly
- Does the chain have any broken or damaged links?

### **5.4.3 Lifting and tilting cylinders**

- Are there any leaks at the seal rings or hose connections
- Are the locking pins for the tilt cylinders secure?
- Check the tilt cylinders by tilting the mast forwards and backwards.

### **5.4.4 Tyres and rims**

- Is there any damage or is there excessive wear and tear
- Check the rims for damage and tears
- Are all wheel nuts present?

### **5.4.5 Bodywork**

- Damage all around the vehicle
- Loose or sharp parts.

### **5.4.6 Controls**

- Do the controls automatically return to neutral after use?

### **5.4.7 Lighting**

- If the vehicle is equipped with lighting, check whether it is properly secured and in good working order.

**5.4.8**

**Cab**

- Is the cab damaged or dented
- Are the windows and doors in working order?

**5.4.9**

**The battery**

- Is the plug in good condition
- Are the cables damaged
- Has the battery been secured
- Is there enough liquid in the battery?
- There should be no oxidation on the battery.

**5.4.10**

**Inspection**

- Material-handling equipment must be inspected periodically by a competent person or institution. This can be done by an independent inspection body, the manufacturer's maintenance service or the company's own technical service, provided that the person or institution concerned is qualified. Written proof of the inspections must be available at the workplace. Inspected equipment must bear an inspection sticker with an inspection date.

**5.4.11**

**Seat**

- Is the seat secure
- Is the upholstery torn
- Is the seat switch or dead man's switch working
- Can the seat be put in the proper position
- Is the seat belt in good working order?



**5.4.12**

**Ignition**

- Insert the key into the ignition and turn it. Newer vehicles can also be started by entering a PIN code or using a key card.
- Check that the hour meter and battery gauge are working properly. The hour meter tracks how long the vehicle has been used. The battery gauge indicates the "charge status" of the traction battery.

**5.4.13**

**Horn**

- Check that the horn is working.

54.14

#### Checking the lifting mechanism

- Raise the mast to the highest position;
- Check the lift chain for wear and the lift cylinders for leakage;
- Hold the lifting handle for a moment and check whether the pressure relief valve is working properly.

*This is done in order to:*

- Check that the lifting mechanism is functioning properly;
- Check the hydraulic oil level;
- Ensure that the entire lifting cylinder is lubricated to prevent rust;
- Check that hoses and pipes are not leaking.

54.15

#### Attachments (general)

- Check that the attachments are functioning properly.

54.16

#### Steering system

- Check the steering system by turning the steering wheel to the left and right;
- There may not be more than 45° of give in the steering wheel.

54.17

#### Parking brake

- Check that the parking brake is functioning properly.

54.18

#### Checking for oil leaks

- Move the vehicle forward until the entire space where it had previously stood is visible. Look back and check whether there is any oil on the floor.



#### **PLEASE NOTE**

Immediately report any leaks to your manager for safety reasons and because of the potential environmental consequences. Clean up liquids such as engine oil, hydraulic oil and coolant using absorption granules and dispose of them as small chemical waste. Neutralise spilled battery fluid with soda and dispose of it.

Make sure to wear the appropriate PPE.

## **5.5 General safety rules**

### **5.5.1 Load stability**

Pay attention to the stability of loose loads. If possible, stack according to recommended stacking patterns. If possible, secure the load with metal or plastic straps or wrapping film. For goods that cannot be stacked, use box pallets.

### **5.5.2 Distribute the load evenly over both forks for good stability**

When lifting long or wide loads of which the midpoint does not coincide with the centre of gravity, drive slowly and be careful that the forklift does not tilt forwards or sideways. Drive especially calmly and slowly when lifting long iron beams.

### **5.5.3 Watch out for bystanders**

Watch out for bystanders when pickup up or setting down a load. Do not allow anyone to stand or pass near or under the load. If necessary, it is up to the operator to warn bystanders to keep their distance.

### **5.5.4 Keep your hands and feet away from the mast**

Never try to stop the load with your hands and feet. Even the smallest mistakes can lead to serious injuries.

### **5.5.5 Watch out for height**

Pay attention to high stacks and any loose objects on top of the load. To protect the operator from falling objects, material-handling equipment has an overhead guard.

### **5.5.6 Lifting loads**

Loads must only be lifted with horizontal forks. When raising or lowering the fork, keep your foot on the brake.

### **5.5.7 Move loads as close to the ground as possible**

Keep the load low, approximately 10-15 cm above the ground. Never lift the load higher than necessary to make sure the load clears the ground or work floor when driving.

### **5.5.8 Make sure the load is resting against the fork carriage**

Never raise or lower loads while driving. Make sure that the entire length of the forks is under the load and that the load rests against the fork carriage.

### **5.5.9 LOOK BEFORE YOU DRIVE!!!!!!!**

Before you drive off, always take a good look around you. Make sure there is enough space to manoeuvre. Check that the direction handle is set to the direction in which you want to travel. Always look in the direction of travel, even when reversing.

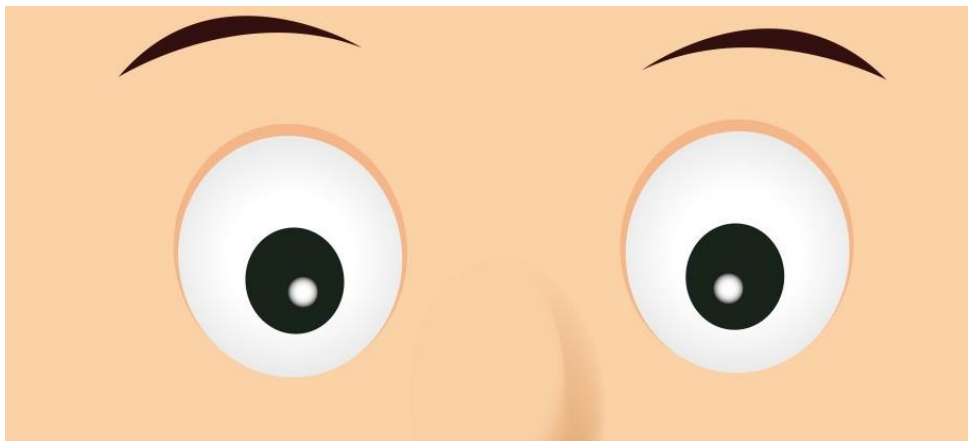

### **5.5.10 Smooth driving**

Avoid sudden acceleration and deceleration. Sudden braking can lead to dangerous situations. The load may slip off the forks, for instance, or the stacker may tip over.

### **5.5.11 Speed management**

Adjust your speed to the circumstances. Keep right as much as possible while driving. Watch out for other traffic, especially pedestrians.

### 5.5.12 **Intended use only**

Your safety depends on your own attitude at work. When things go wrong, the vehicle is not to blame. YOU or the rider are at fault. Do not pull any stunts or pranks.

### 5.5.13 **Skidding hazards**

Make sure the electric pallet truck or stacker truck does not skid. Floors covered in water or oil pose a skid risk. You can avoid skidding by adjusting your speed, braking gently and evenly and steering carefully, especially when cornering.



### 5.5.14 **Focus**

When driving, operators must focus, assess possible hazards properly and have a good understanding of the workplace and the work that is done there. It is therefore up to us to use vehicles safely in order to prevent damage and accidents. Always look in the direction of travel, despite the many distractions you may encounter along the way.

### 5.5.15 **Approaching junctions**

When approaching a junction, you must adjust your speed. Always watch out for other traffic. Sound your horn in time.

### 5.5.16 **Horn**

You should use the horn in various special situations, not just when approaching a junction. Make sure to use the horn selectively.

### 5.5.17 **Loose objects**

Never drive over loose objects lying on the floor. Move them out of the way rather than driving over them. Avoid driving over potholes as much as possible.

### 5.5.18 **Clearance**

Make sure that you do not collide with highly placed objects, such as lamps, wiring, pipes and sprinkler systems. Pay particular attention to the different clearance heights in warehouses.

**5.5.19****Manoeuvring**

Make sure you have enough space, especially when transporting wide loads. In narrow aisles, stick to the middle as much as possible. Be mindful of racking and other materials along your way.

When cornering, remember that the rear of the vehicle swings in the opposite direction of the turn. If, for example, you are driving forward in a forklift and take a left turn, the rear of the vehicle will swing to the right. Remember that the load will need more space to corner than the truck itself.

**5.5.20****Body parts**

Keep your arms or legs inside the confines of your vehicle. You only have one set of arms and legs, and only one head. Take care of them!

**5.5.21****High loads**

When your forward view is obstructed by a high load, drive in reverse. Example: if you cannot see the floor 3 metres ahead of you, drive in reverse.

**5.5.22****Loading and unloading lorries**

Make sure that the lorry will not be able to drive off suddenly while you are entering it on an electric pallet truck or stacker. Block the wheels with a wheel chock. Keep the low ceiling in mind and check the loading floor. When loading a lorry with a loading ramp, check that it is anchored to the vehicle.

**5.5.23****Passenger transport**

Do not use electric pallet trucks or stackers to transport passengers. There is no safe place for passengers on electric pallet trucks or stackers.



## 5.5.24

### Parking

Vehicles must be parked as follows:

- Park in such a way that you can dismount in a normal fashion
- Straighten the wheels
- Tilt the mast forward
- Forks on the floor
- Engage the parking break
- Neutralize the controls
- Turn off the ignition switch
- Take the key or chip card

Do not block:

- doors or other passageways
- fire extinguishers or first-aid kits
- walking and transport routes

## 5.5.25

### User manual

It goes beyond the scope of this textbook to cover every single type of material-handling equipment in detail. For more detailed information, please refer to the user manual of the electric pallet truck or stacker in question. A user manual must be present for each vehicle in the workplace.

## Final Tip

**SAFETY STARTS WITH YOU. DON'T  
JUST THINK OF YOUR OWN  
SAFETY, BUT THE SAFETY  
OF OTHERS TOO!**





# Notes

---

---

---

---

---

---

---

---

---

---

---

---

---

---

---

---

---

---

---

---

---

---

---

---

---

---

---

---

---

---